

LANDA®

Since 1969

Industrial Pressure Washers
...Built Right to Do the Job Right

SUREFIRE

High Efficiency Oil Burner Engineered
Specifically for the Pressure Washer Industry

- Patent-Pending Oil Burners by LANDA
- 0.75 to 3.0 GPH
- 56,000 to 420,000 BTU
- ETL Listed to UL and CSA Safety Standards

■ Exceptional performance even at low GPH for a wide range of applications

■ Easy to service due to overall simple ease of making adjustments and overall design

■ Corrosion-free die cast aluminum fan housing with slide-in guide for forged brass gun assembly

■ Forged brass gun assembly with self-aligning electrodes for reliable ignition

■ Water-tight electrical box with numbered terminal strip and wiring diagram for quick and easy installation

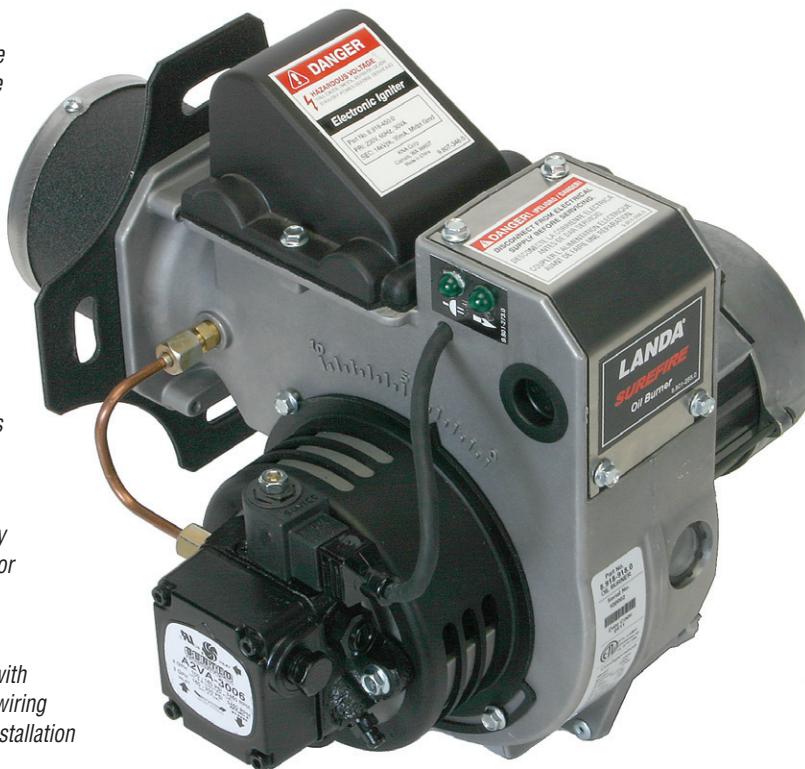

■ Sight glass for viewing spark, ignition, and fan provides at-a-glance performance monitoring of inside of burner

■ Solid State, high output ignitors for better ignition

■ Power and ignition indicator lights show that burner is working

■ Dependable Suntec fuel pumps are the best in the industry

■ Fuel options include No. 1 or 2 heating oil, No. 1 or 2 diesel fuel, or kerosene

■ ETL listed to UL and CSA safety and performance standards

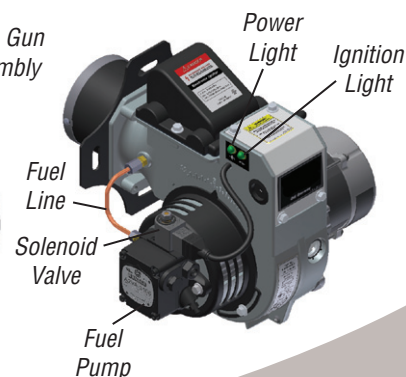
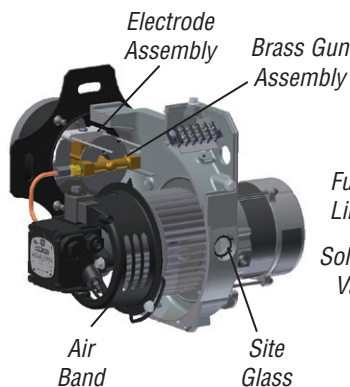
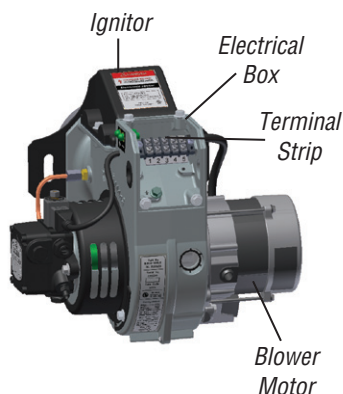
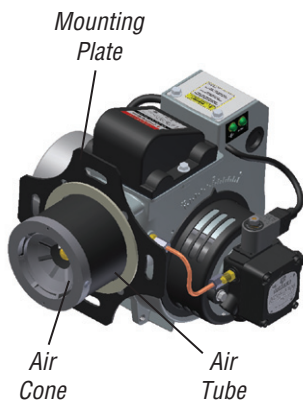

www.landa.com

LANDA®

Industrial Pressure Washers
...Built Right to Do the Job Right

Since 1969

SUREFIRE

High Efficiency Oil Burner Engineered
Specifically for the Pressure Washer Industry

- Patent-Pending Oil Burners by LANDA
- 0.75 to 3.0 GPH
- 56,000 to 420,000 BTU
- ETL Listed to UL and CSA Safety Standards

Oil Burners by LANDA

SureFire oil burners by LANDA are a leader in performance, reliability, and energy efficiency. Industry exclusive features provide a durable, maintenance free package.

Designed especially for the harsh environment of the pressure washer industry, these burners are built to provide years of trouble free service. LANDA products are built right to do the job right.

LANDA SureFire Oil Burner Specifications

Features, Ratings and Specifications

Part Number	Motor/Ignitor Voltage	Motor	Solenoid Voltage	Air Cone Size	Firing Rate Min. (GPH)	Firing Rate Max. (GPH)	Tube Length
8.918-916.0	120V	1/6 HP, 3450 RPM, continuous-duty, split-phase, capacitor-start	24V	F22	2.0	3.0	3 in.
8.918-914.0			24V	F12	1.25	2.0	3 in.
8.918-913.0			120V	F22	2.0	3.0	3 in.
8.918-915.0			120V	F12	1.25	2.0	3 in.
8.918-920.0			120V	F4	0.75	1.25	3 in.
8.918-917.0	230V	1/6 HP, 3450 RPM, continuous-duty, split-phase, capacitor-start	24V	F22	2.0	3.0	3 in.
8.918-918.0			120V	F22	2.0	3.0	3 in.
8.918-919.0	12VDC	1/7 HP, 3450 RPM, continuous-duty, shunt-wound	12-24V	F22	2.0	3.0	3 in.

Dimensions in inches for all models

A	B	C	D	E	F
12.25	3.0	5.75	13.0	3.0	6.0

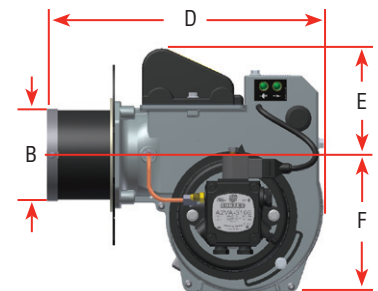
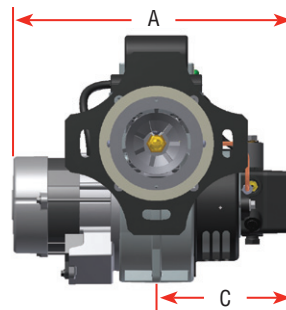

LANDA®

Distributed by:

www.landa.com